

中国高端电脑缝纫机

CHINESE HIGH-END COMPUTERIZED SEWING MACHINE

HIKARI® 富山

使用说明书

INSTRUCTION MANUAL

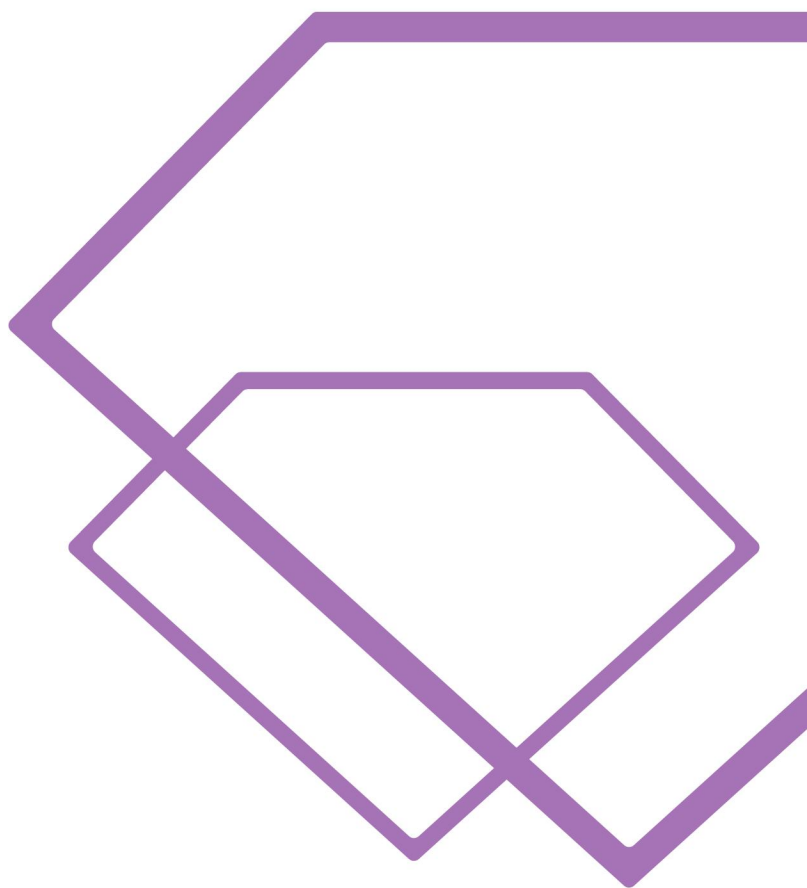

HX8V 系列
Series

超高速线张力自平衡电脑包缝机

COMPUTERIZED STEPPER DRIVE INTELLIGENT
SUPER - HIGH SPEED OVERLOCK SEWING MACHINE

V1.00

目 录

一、显示及操作界面.....	2~3
二、用户区参数的修改.....	4
三、自动/半自动模式的修改.....	4
四、剪线模式的修改.....	4
五、抬压脚模式的修改.....	4
六、转速的修改.....	5
七、布料选择模式及光眼值校正.....	5
八、停针位选择.....	5
九、快捷恢复参数.....	5
十、操作参数说明表.....	6~9
十一、电控相关的要求及操作使用注意事项.....	10~15

一、显示及操作界面





序号	图标	说明	备注
1		用户参数设定键	点按为退出参数的快捷；长按为设值参数的快捷
2		语言切换键和左移键	点按语言切换；左移动光标；
3		抬压脚快捷键和右移键	点按为压脚模式切换，长按为抬压脚参数调整；右移动光标；
4		速度加速键和上移键	点按为速度加；参数项加和参数值加；
5		速度减速和下移键	点按为速度减；参数项减和参数值减；
6		确认键	修改参数值确认
7		LED 亮度调整和停针位选择	点按为 LED 亮度加；长按为停针位选择
8		缝纫模式转换键	点按为缝纫模式切换键
9		剪线模式调整键	点按为剪线模式切换；长按为剪线参数调整
10		恢复键	长按 3 秒恢复用户参数
11		布料切换键	点按为选择布料的快捷；双击为光眼值查看和粗调





二、用户区参数的修改

 当用户长按  键时，进入用户参数模式；通过点按  或  修改对应的参数号，通过点按  或  键修改对应的参数值，点按  键确认。显示相应的参数序号及参数内容，当用户点按下  键，退回到主界面。





三、自动/半自动模式的修改

 当用户点按下  键时，进入人工、半自动、自由缝和全自动模式的修改状态，循环点按  键时，工作模式循环如以下四种状态：人工、半自动、自由缝和全自动





四、剪线模式的修改

 当用户点按下  键时，即可修改剪线模式。循环点按  键时，模式循环如以下四种状态：前剪线开、后剪线开、前、后剪线开、前、后剪线关闭（备注：当剪线模式打开或关闭时，吸气模式自动同步打开或关闭，如当前、后剪线开时，前、后吸气同步自动打开）；长按  键时，为剪线相关参数调整的快捷键。

五、抬压脚模式的修改

 当用户点按  键时，即可修改抬压脚模式。循环点按  键时，模式循环如以下四种状态：前抬压脚开、后抬压脚开、前、后抬压脚开、前、后剪线关闭；
 当长按  键时，为抬压脚相关参数调整的快捷键。



六、转速的修改

点按一下  或  键即可进入转速修改界面。循序点按或长按  或  可以修改相应速度，按一下递加或减 100rpm。显示如下：

最大速度	6200
------	------





七、布料选择模式及光眼值校正

1) 首次点按  键时为布料选择模式，点按     键调整对应布料模式，当前界面再次点按  键是查看光眼数值和手动微调光眼数值；

2) 出厂默认为普通布料，当遇到不同布料时，请先点按  键，出现“布料选择”界面时，根据不同的需求选择相应的布料，再按  键，系统自动校正光眼值；

3) 布料适用范围：A:厚料 B:普通 C:薄料 D:透明 E:大网 F:小网
备注：在选择布料时，请勿将布料遮挡光眼；在正常使用系统时，要及时清理光眼上的布屑等。

八、停针位选择

长按  键 3 秒，会进入针位选择界面，点按  或  键调整所需停针位，点按  键确认选择

九、一键恢复功能

长按  键 3s，会自动恢复出厂设置，当恢复界面跳回主界面时即恢复成功

十、操作参数说明表

序号	功能参数	默认值	设定范围	单位	参数说明	备注
U1	工作模式	0	0~1		0: 半自动 1: 全自动	
U2	电眼选择	1	0~1		0: 关闭 1: 开启	
U3	自动剪线	3	0~3		0: 关闭剪线 1: 前剪线开 2: 后剪线开 3: 前、后剪线开	
※※	自动剪线	2	0~3		0: 关闭剪线 1: 前剪线开 2: 后剪线开 3: 前、后剪线开	83BL
U4	自动吸气	3	0~3		0: 关闭吸气 1: 前吸气开 2: 后吸气开 3: 前、后吸气开	
※※	自动吸气	2	0~3		0: 关闭吸气 1: 前吸气开 2: 后吸气开 3: 前、后吸气开	83BL
U5※※	后踏吸线模式	2	0~2		0: 关闭 1: 普通模式 2: 盖布长吸	83BL
U6	自动抬压脚	0	0~3		0: 关闭自动抬压脚 1: 前抬压脚 2: 后抬压脚 3: 前、后抬压脚	
※※	自动抬压脚	2	0~3		0: 关闭自动抬压脚 1: 前抬压脚 2: 后抬压脚 3: 前、后抬压脚	83BL
U7※	松线开关	2	0~3		0: 关闭 1: 前松线开 2: 后松线开 3: 前、后松线开	KSC
※※	松线开关	3	0~3		0: 关闭 1: 前松线开 2: 后松线开 3: 前、后松线开	83BL
U8※※	吸线开关	3	0~3		0: 关闭 1: 前吸线开 2: 后吸线开 3: 前、后吸线开	83BL
U9	自由缝	1	0~1		0: 关闭 1: 开启	
U10	半自动恒速剪线	0	0~2		0: 关闭 1: 前后恒速剪线, 中途任意加速; 2: 点动恒加速	
U11						预留
U12	最高速度	6200	200~7000	RPM	根据客户需求适当自行做调整	
U13	按键音	1	0~1		0: 关闭 1: 开启	
U14						预留
U15	起缝速度	5500	200~6000	RPM	根据客户需求适当自行做调整	
※※	起缝速度	3600	200~6000	RPM	根据客户需求适当自行做调整	83BL
U16※※	起缝针数	12	0~200		根据客户需求适当自行做调整	83BL
U17						预留
U18	中途吸气模式	0	0~2		0: 关闭 1: 间吸气 2: 长吸气	
U19	间歇吸气开启针数	25	0~1000			
U20	间歇吸气关闭针数	25	0~1000			
U21	两传感器间针数	20	0~99		根据要求客户可自行调整参数	
U22	前剪线延迟针数	60	0~600		根据要求客户可自行调整参数	
U23	后剪线延迟针数	114	0~600		根据要求客户可自行调整参数	
※※	后剪线延迟针数	80	0~600		根据要求客户可自行调整参数	83BL

U24	前吸气开启针数	3	1~99		根据要求客户可自行调整参数	
※	前吸气开启针数	1	1~99		根据要求客户可自行调整参数	KSC
U25	前吸气关闭针数	10	1~99		根据要求客户可自行调整参数	
※	前吸气开启针数	14	1~99		根据要求客户可自行调整参数	KSC
U26	后吸气开启针数	3	1~99		根据要求客户可自行调整参数	
※	前吸气开启针数	3	1~99		根据要求客户可自行调整参数	KSC
U27	后吸气关闭针数	120	10~9999ms		根据要求客户可自行调整参数	
※	前吸气开启针数	260	1~99		根据要求客户可自行调整参数	KSC
U28	吸屑启动针数	0	0~99			预留
U29	吸屑关闭针数	0	0~99			预留
U30※	松线开启针数	120	0~99		根据要求客户可自行调整参数	KSC
U31※	松线关闭针数	360	0~5000		根据要求客户可自行调整参数	KSC
U32※	松线运行针数	10	0~99		0: 为关闭手动剪功能;	KSC
U33※	松线运行速度	5000	200~6000			KSC
U34						预留
U35	间歇吸屑开启针数	5	2~99			预留
U36	间歇吸屑关闭针数	5	2~99			预留
U37	网布模式	0	0~1		0: 关闭 1: 开启	
U38						预留
U39	停车延迟针数	10	1~200		根据要求客户可自行调整参数	
※	停车延迟针数	35	1~200		根据要求客户可自行调整参数	KSC
※※	停车延迟针数	3	1~200		根据要求客户可自行调整参数	83BL
U40	前抬压脚延迟时间	0	0~6000			
U41	前抬压脚保留时间	260	5~6000	MS		
U42	后抬压脚启动时间	0	0~6000			
U43	后抬压脚保留时间	500	0~9999			
U44	半自动连续缝制	0	0-1		0: 关闭 1: 开启	
U45	中途间歇吸屑停留	350	0~9999			预留
U46	自动切刀保留时间	10	5~500		根据要求客户可自行调整参数	
U47	后踏吸气时间	500	50~9999			
U48※	手动松线时间	280	0~5000			KSC
U49	手动吸气时间	260	10~5000			
U50※	前踏吸气针数	0	0~5000		根据要求客户可自行调整参数	KSC
U51	后踏吸气开关	1	0~7		0 全关;1 人工开;2 半自动开;3 全自动开;4 人工和半自动开;5 半自动和全自动开;6 人工全自动开;7 人工、半自动和全自动开	
U52	后踏剪线开关	1	0~7		0 全关;1 人工开;2 半自动开;3 全自动开;4 人工和半自动开;5 半自动全自动开;6 人工和全自动开;7 人工半、半自动和全自动开	

U53	手动吸气开关	7	0~7		0 全关;1 人工开;2 半自动开;3 全自动开;4 人工和半自动开;5 半自动和全自动开;6 人工全和自动开;7 人工、半自动和全自动开	
U54	手动切线开关	7	0~7		0 全关;1 人工开;2 半自动开;3 全自动开;4 人工和半自动开;5 半自动全自动开;6 人工全自动开;7 人工半自动全自动开	
U55	手动切线动作有效	0	0~2		0 无布时动作;1 有布时动作 ;2 随时动作	
U56※	手动松线动作有效	0	0~2		0 无布时动作;1 有布时动作 ;2 随时动作	KSC
U57	后踏切线动作有效	0	0~2		0 无布时动作;1 有布时动作 ;2 随时动作	
U58※	后踏松线动作有效	0	0~2		0 无布时动作;1 有布时动作 ;2 随时动作	KSC
U59※	后踏松线开关	0	0~7		0 全关;1 人工开;2 半自动开;3 全自动开;4 人工和半自动开;5 半自动全自动开;6 人工全自动开;7 人工半自动全自动开	KSC
U60※	手动松线开关	7	0~7		0 全关;1 人工开;2 半自动开;3 全自动开;4 人工和半自动开;5 半自动全自动开;6 人工全自动开;7 人工半自动全自动开	KSC
U61	侧吸切刀传动	0	0~1		0: 电机传动 1: 电磁铁传动	预留
U62						预留
U63						预留
※※	前松线开启针数	0	0~100			83BL
U64						预留
※※	前松线关闭针数	1	1~100			83BL
U65						预留
※※	后松线开启针数	0	0~100			83BL
U66						预留
※※	后松线关闭针数	800	5-9000	Ms		83BL
U67						预留
U68※	前松线开启针数	0	0~99		根据客户需求适当自行做调整	KSC
※※	前吸线开启针数	0	0~99		根据客户需求适当自行做调整	83BL
U69※	前松线关闭针数	05	0~99		根据客户需求适当自行做调整	KSC
※※	前吸线关闭针数	25	0~99		根据客户需求适当自行做调整	83BL
U70※※	后吸线开启时间	300	0~359			83BL
U71※※	后吸线关闭时间	680	0~9000			83BL
U72※※	后踏吸气时间	580	0~9000			83BL
U73※※	速度调控	4000	200~6000			83BL

U74	前放压脚模式	0	0-1		0: 关闭 1: 开启	
U75	刹车针杆位置	0	0~1		0: 缝制中途上针位, 缝制结束停上针位 1: 缝制中途下针位, 缝制结束停上针位;	
U76						
U77	前通道响应时间	30	30~500			
U78	中通道响应时间	20	20~200			
U79	后通道响应时间	5	2~200			
U80	前通道灵敏度	65	0~99		此款系统禁止调整, 请在快捷键选择布料自动校正	
U81	中通道灵敏度	60	0~99		此款系统禁止调整, 请在快捷键选择布料自动校正	
U82	后通道灵敏度	40	0~99		此款系统禁止调整, 请在快捷键选择布料自动校正	
U83	前通道响应值	30	5~120		此款系统禁止调整, 请在快捷键选择布料自动校正	
U84	中通道响应值	40	5~120		此款系统禁止调整, 请在快捷键选择布料自动校正	
U85	后通道响应值	40	5~120		此款系统禁止调整, 请在快捷键选择布料自动校正	
U86	安全开关	3	0~3		0 全关;1 压脚安全开关关闭;2 缝台安全开关关掉;3 压脚、缝台安全开关全开	
U87	压脚安全开关电平	0	0~1		0: 开启 1: 取消开关	预留
U88	缝台安全开关电平	0	0~1		0: 开启 1: 取消开关	预留
U89	压脚保护时间	10	5~9999s			
U90	界面恢复时间	120	0~9999		0~~9999:	
U91	背光对比度	18	6~45			
U92	背光亮度	10	0~10			
U93	机头灯亮度	3	0~5			
U94	参数密码		0~9999			
U95	恢复出厂设置	0	0~9999			
U96	语言	0	0~1		0: 中文 1: 英文	
U97	软件版本 1		0~9999		SA78XX 为面板	
※※	软件版本 1		0~9999		PA85XX 为面板	83BL
U98	软件版本 2		0~9999		SC68XX 为主板	
※※	软件版本 2		0~9999		PC85XX 为主板	83BL
U99	软件版本 3		0~9999		PB78XX 为主板端口程序	
UA0	语音音量	20	0~30		根据要求客户可自行调整参数	

十一、 电控相关的要求及操作使用注意事项

0.主要技术数据

供电电压范围：AC220V±15%

供电电源频率：50Hz/60Hz

1、 安全注意事项

1.1 使用范围

本伺服控制器是为工业缝纫机开发设计的，如果在其它方面使用，请注意使用者的安全。

1.2 工作环境

1.2.1 电源电压请遵照电控电压±15%范围内。

1.2.2 请远离高频电磁波发射器等，以免所产生的电磁波干扰本控制器而发生错误动作。

1.2.3 温湿度：

a.请在室温 5°C 以上、 45°C 以下的场所操作。

b.禁止在日光直接照射的场所或室外运作。

c.请不要过于接近暖气 (电热器) 旁运作。

d.请保持 30 % ~ 95 % 相对湿度（无凝露）。

1.2.4 请不要在可燃气体或爆炸物附近操作。

1.3 安装

1.3.1 控制器请遵照说明书进行正确安装。

1.3.2 安装前请先关闭电源并拔掉电源线插头，然后进行安装。

1.3.3 装钉电源线时请避免靠近会转动部件，最少要离开3公分以上。

1.3.4 为防止噪声干扰或触电事故，请将缝纫机、控制箱接地。



1.3.5 打开电源之前，确定此供应电压必须符合电控指定电压±15%范围内。

1.4 保养维修的规定

1.4.1 在操作保养或维修动作前，请先关闭电源。

1.4.2 当翻抬机头，更换机针或穿线时，请确认电源已关闭。

1.4.3 控制箱里面有危险高压电，所以关闭电源后要等 5 分钟以上方可打开控制箱。

1.4.4 修理及保养的作业，要请经过训练的技术人员执行。

1.4.5 不能在电机及控制箱运转的状态下进行保养或维修。

1.4.6 所有维修用的零件，须由本公司提供或认可，方可使用。

1.5 危险提示



这个标示符号表示机器在安装时，安全上需要特别加以注意的事项，忽视此标记而进行错误操作可能会导致人员或是机器损伤。

1.6 其它安全规定

- 1.6.1、在第一次接通电源后，请先以低速操作缝纫机并检查转动方向是否正确。
- 1.6.2、缝纫机运转时，请不要去触摸手轮、机针等会动作的部位。
- 1.6.3、所有可动作的部份，必须以所提供的防护装置加以隔离，防止身体接触，请勿在装置内塞入其它物品。
- 1.6.4、请不要在拆下电机护罩及其它安全装置的情形下操作。
- 1.6.5、不要使电机或控制箱掉在地上。
- 1.6.6、不要让茶水等液态物体流入控制箱或电机内部。

2. 安装与调整

2.1 控速器的安装

- 1).将脚踏控速器安装于台板下方
- 2). 将踏板与控速器安装连结
- 3).安装后示意图

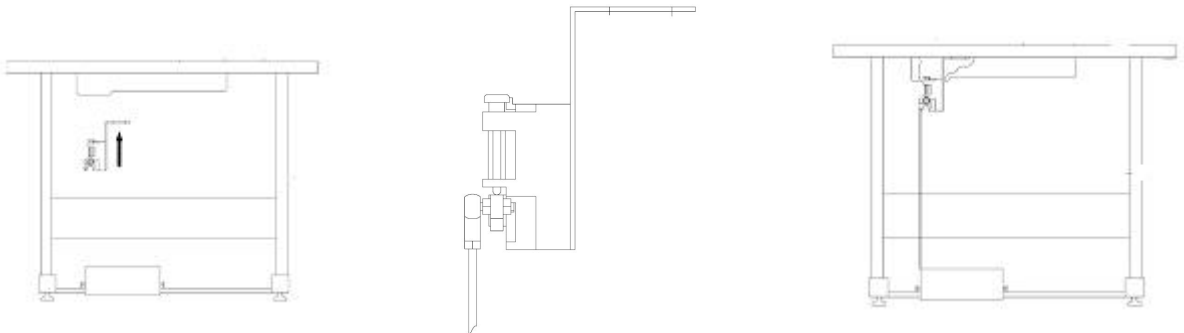

2.2 停针位的调整

- 2.2.1、 由专业的技术人员通过操作界面的学习界面，可调整到合理的停针位置；

2.3 脚踏板后踏力量的调整

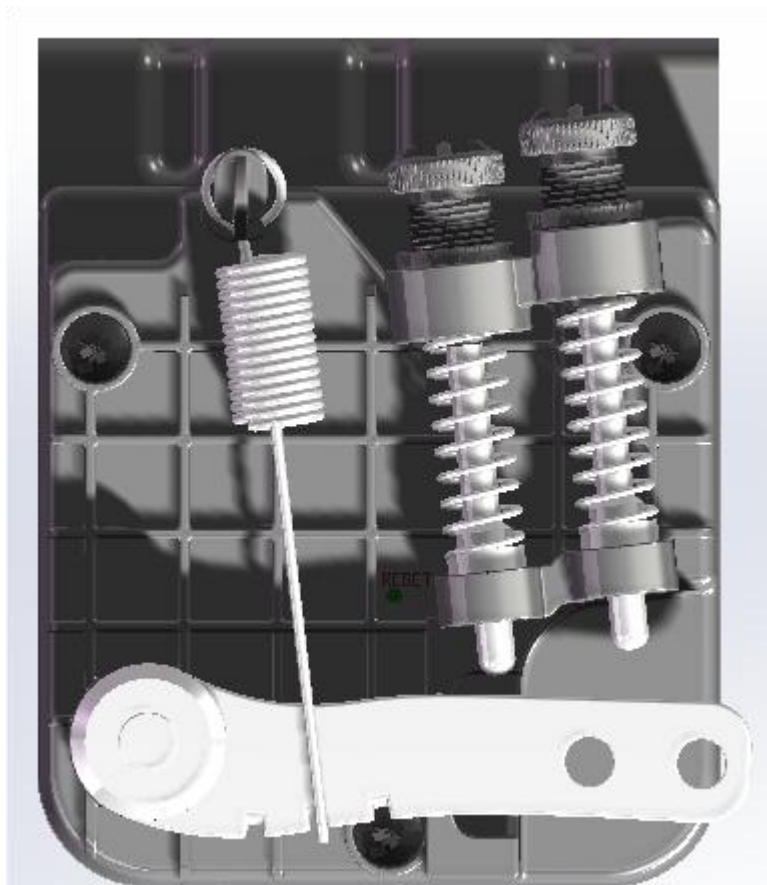

调整需求	调整结果
踏板后踏力量的调整	当螺栓愈向下时，则后踏力量愈重。当螺栓愈向上时，则后踏力量愈轻。

3. 接线与接地

3.1 电源线的接法

本控制器适用于AC220V单相电源，电压输入范围为电控电压 $\pm 15\%$ 。



注意：

黄/绿色电源线为接地线，为了人员安全及设备可靠工作，一定要做好系统的接地工程。

3.2 控制器接线端子图：如下图



序号	端口名称	
1	电控电源端口	
2	34V	松线 (KSC)
	预留	预留
	34V	吸风
	预留	预留
	34V	倒回缝 (吸线头)
3	34V	倒回缝 (松线)
	机灯	中光眼发射
	12V	前光眼发射
	5V	手动剪线
4	5V	后光眼发射
4	5V	前光眼接收
5	5V	中光眼接收
6	5V	后光眼接收
7	5V	GND
	压脚霍尔	预留
8	5V	缝台安全开关
9	5V	预留
	GND	NET31-1
10	5V	RXD
	GND	TXD
11	主程序升级端口	
12	步进电机编码器端口	
13	步进电机电源端口	
14	电机编码器端口	
15	电机电源端口	



各部的连接插头于插入控制箱的插座时，要注意其形状、颜色和方向性，并确实插好。

4. 故障分析和故障表

故障显示代码	故障描述	故障原因	故障排除方法
Er01	找不到停针位	电机信号线端子头接触不良	断电后检查电机信号线是否松动，然后重新上电，如果还不能解决，请联系售后服务人员
Er02	控速器信号错误	1: 开机时没插调速器 2: 控速器线接触不良 3: 后踩住控速器开机	断电后检查控速器连接或插头是否接触不良，然后重新上电，如果还不能解决，请联系售后服务人员
Er03	电机相位信号错误	电机信号线插头接触不良	断电后检查电机信号线是否松动，然后重新上电，如果还不能解决，请联系售后服务人员
Er04	电机堵转保护	1: 缝纫机过重或堵死 2: 电机过载 3: 电机 4 线驱动线没连接好或插反	断电后检查： 1、请检查机头是否被卡住 2、请检查电机是否被卡住 3、电机电源端子脱落或松动 然后重新上电，如果还不能解决，请联系售后服务人员
Er05	硬件过流保护	1: 缝纫机过重或堵死 2: 电机过载 3: 电机相位信号线没连接好	断电后检查： 1、请检查机头是否被卡住 2、请检查电机是否被卡住 3、电机电源端子脱落或松动 然后重新上电，如果还不能解决，请联系售后服务人员
Er07	示屏和主板通讯超时	1: 显示屏连接主板线连接不良 2: 主板芯片损坏	1: 检查显示屏与控制器连接线 2: 检查控制器是否还可运行，如不能运行就是控制器损坏 3: 检查机器旁是否有高频机器干扰 4: 更换显示屏
Er09	存储器不良	主板存储器损坏或不良	控制器损坏，请联系售后服务人员
Er10	光眼控制线路故障	显示屏连接光眼线路不良	1: 显示屏损坏 2: 显示屏背部光眼连接线接触不良，请联系售后服务人员
Er12	编码器故障		联系售后服务人员
Er16	过压	电压超出限制范围	请检查输入电源电压是否在额定范围内（AC260V），若上述无法解决，请联系技术人员
Er17	A 相电流检测故障		请联系售后服务人员
Er18	B 相电流检测故障		请联系售后服务人员
Er19	AB 相电流检测故障		请联系售后服务人员

Er20	欠压故障	电压低于限制范围	请检查输入电源电压是否在额定范围内（AC 180V），若上述无法解决，请联系技术人员
Er22	控速器故障	1. 前踩控速器开机 2. 控速器数值不对	1. 重新前踏控速器解除 2. 按 P 键+剪刀剪进入维护参数，再按 OK 键查看（ 200±15% ），数值大于则更换控速器
ER-35	步进电机硬件过流保护	1: 检查步进电机信号线是否松动; 2: 检查步进电机电源线是否松动	若不能解决，请联系售后服务人员
ER-37	步进电机相 A 电流检测故障	主板芯片损坏	请联系售后服务人员
ER-38	步进电机相 B 电流检测故障	主板芯片损坏	请联系售后服务人员
ER-39	步进电机相 AB 电流检测故障	主板芯片损坏	请联系售后服务人员
ER-45	步进电机编码器故障	检查步进电机信号线是否松动	若不能解决，请联系售后服务人员











5.此说明书仅作参考，如有更改恕不另作通知。

Contents







1、 Display and operation panel.....	- 2 -18
2、 Modification of user parameters.....	19
3、 Modification of auto & semi-auto mode.....	19
4、 Modification of the trimming mode.....	19
5、 Modification of the mode for lifting presser foot.....	19-20
6、 Modification of the speed.....	20
7、 Cloth select mode and sensor value correction	20
8、 Needle position selection	20
9、 Quick reset parameter	21
10、 Form of the operation parameters.....	21~25
11 、 Electrical control related requirements and operating precautions.....	25~31

1、 Display and operation panel





序号	图标	说明	备注
1		User parameter setting key	Hot key to exit the parameter when tap it; Hot key to set the parameter when long press it.
2		Language switching key and left switching key	Tap to switch language , left switch the cursor
3		Presser foot hot key and right switching key	Tap to switch language , left switch the cursor
4		Speed increase key and up switching key	Tap to increase speed. Parameter items and value increase
5		Speed decrease key and down switching key	Tap to decrease the speed, parameter item and value decrease
6		Confirm key	Value modification confirm
7		LED adjustment and needle position	Tap to increase the LED light, long press it to choose the needle position
8		Sewing mode switching key	Tap to switch the sewing mode.
9		Trimmer mode select	Tap to switch the trimmer mode, long press it to change the trimming value.
10		Reset key	Long press it 3 secs to reset to the user parameter
11		Fabric switching key	Hot key for choosing fabric when tapping it. Sensor value review and brief adjustment while double clicking it.



2、 Modification of user parameters

When the user long press , enter the user parameter mode; Through  , modify the corresponding parameter number; Through  , modify the corresponding parameter number; Confirm with ; When the user clicks , it will return to the main page .

3、 Modification of auto & semi-auto mode

When the user clicks  缝纫模式
Sewing mode, enter the manual, semi-automatic and fully automatic mode of modification; When the keys are cycled, the modes are circulated in the following three states: manual, semi-automatic and fully automatic; Long press  缝纫模式
Sewing mode, related parameters to adjust the shortcut keys.



4、 Trimming mode select

Press then  剪线
Trimming to select the trimming mode. Repeating pressing  剪线
Trimming key to have the for modes: front trimer on, rear trimmer on, front& rear trimer on, front&rear trimmer off.

(Note: When the trimming mode is on or off, suction mode simultaneously on or off, when the front&rear trimmer is on,front&rear suction is on)

Long press  剪线
Trimming key to enter the hot key mode of trimming parameter adjusting)

5、 Press foot mode select

Tap the  抬压脚
Foot lifter key to select the presser foot mode. Repeating press the  抬压脚
Foot lifter key to have four modes: front foot on, rear foot on, front&rear foot on, front&reat foot off.





Long press  key to enter the hot key mode of presser foot parameter selecting

6、Speed select



Tap  or  key to enter the speed selecting mode. Repeating







tap  or long press the  key to modify the speed, 100rpm speed increasing or decreasing when tapping once.

Speed	6200
-------	------

7、Cloth select mode and sensor value correction





1) Press the  for the cloth selecting mode, tap     key to select the fabric mode



Press the  again to review the sensor value and to manually micro adjust the value

2) The setting mode is for the normal fabric, when stitching different type fabric, pls



press  to choose different mode, and press  again, the system will automatically correct the value ;

3) Cloth: A: Heavy B: Medium C: Thin D: Transparent E: Large hole mesh F: Small hoe mesh



PS: Pls donot cover the sensor when choose the adjust the cloth mode, and pls clean the sensor in time when using the machine

8、Needle position select



Long press the  key 3 secs to enter the needle position selecting mode, tap the



 or  to choose the needle position, and tap  to confirm.

9、one-key reset function.



Long press 3 secs to reset, the reset is done when the reset interface return to the main interface.

10、Form of the operation parameters

No	Function	Default value	Setting range	Unit	Explanation	Notes
U1	Work mode	0	0~1		0: Semi-Auto 1: Auto	
U2	Sensor selection	1	0~1		0: Off 1: On	
U3	Auto trimming	3	0~3		0: Trimmer Off 1: Front trim 2: Rear trim 3: Front & Rear trim	
※※	Auto trimming	2	0~3		0: Trimmer Off 1: Front trim 2: Rear trim 3: Front & Rear trim	83BL
U4	Auto suction	3	0~3		0: Air Off 1: Front Suction 2: Rear Suction 3: Front & Rear suction	
※※	Auto suction	2	0~3		0: Air Off 1: Front Suction 2: Rear Suction 3: Front & Rear suction	83BL
U5※※	R-Pedal suction model	2	0~2		0: Off 1: Normal 2: Long Suction	83BL
U6	Auto lift presser foot	0	0~3		0: Lifter Off 1: Front lifting foot 2: Rear lifting foot 3: Front & Rear lifting foot	
※※	Auto lift presser foot	2	0~3		0: Lifter Off 1: Front lifting foot 2: Rear lifting foot 3: Front & Rear lifting foot	83BL
U7※	Thread release	2	0~3		0: Loose Off 1: Front Loose 2: Rear Loose 3: Front & Rear Loose	KSC
※※	Loose switch	3	0~3		0: Loose Off 1: Front Loose 2: Rear Loose 3: Front & Rear Loose	83BL
U8※※	Thread suction	3	0~3		0: Off 1: Front Suction line 2: Rear Suction line 3: Front & Rear Suction line	83BL
U9	Free Sewing	1	0~1		0: Off 1: On	
U10	Fxd speed trim	0	0~2		0:off 1: Front & rear fixed speed trimming, and accelerate 2: Pedal press to accelerate	
U11						Reserve
U12	Max speed	6200	200~7000	RPM		
U13	Key tone	1	0~1		0: Off 1: On	
U14						Reserve
U15	Start speed	5500	200~6000	RPM		
※※	Start speed	3600	200~6000	RPM		83BL
U16※※	Start stitches number	12	0~200		Adjusting parameters to customer requirements	83BL
U17						Reserve

U18	I-Suction Mode	0	0~2		0: Off 1: Internal Suction 2: Long Suction	
U19	I-Suction on S-N	25	0~1000			
U20	I-Suction off S-N	25	0~1000			
U21	S- N between two sensors	20	0~99		Adjusting parameters to customer requirements	
U22	F-trimming delay S-N	60	0~600		Adjusting parameters to customer requirements	
U23	R-trimming Delay S-N	114	0~600		Adjusting parameters to customer requirements	
※※	R-trimming Delay S-N	80	0~600		Adjusting parameters to customer requirements	83BL
U24	F- suction on S-N	3	0~99		Adjusting parameters to customer requirements	
※	F- suction on S-N	1	0~99		Adjusting parameters to customer requirements	KSC
U25	F- suction off S-N	10	1~99		Adjusting parameters to customer requirements	
※	F- suction off S-N	14	1~99		Adjusting parameters to customer requirements	KSC
U26	R –suction on S-N	3	1~99		Adjusting parameters to customer requirements	
※	R –suction on S-N	3	1~99		Adjusting parameters to customer requirements	KSC
U27	R-suction off time	120	10~9999	ms	Adjusting parameters to customer requirements	
※	R-suction off time	260	10~9999	ms	Adjusting parameters to customer requirements	KSC
U28	Dust suction on S-N	0	0~99			Reserve
U29	Dust suction off S-N	0	0~99			Reserve
U30※	R- thread release on S-N	120	0~600			KSC
U31※	R- thread release off S-N	360	0~5000			KSC
U32※	Thread Release run S-N	10	0~99		0: manual trimmer off	KSC
U33※	Thread Release run speed	5000	200~6000			KSC
U34						Reserve
U35	I-D suction on S-N	5	2~99			Reserve
U36	I-D suction off S-N	5	2~99			Reserve
U37	Mesh Mode	0	0~1		0: Off 1: On	
U38						Reserve
U39	Stop delay S-N	10	1~200		Adjusting parameters to customer requirements	
※	Stop delay S-N	35	1~200		Adjusting parameters to customer requirements	KSC
※※	Stop delay S-N	3	1~200		Adjusting parameters to customer requirements	83BL
U40	F-lift foot delay time	0	0~6000			
U41	F-lift foot holding time	260	5~6000	MS		
U42	R-lift foot start time	0	0~6000			
U43	R-lift foot holding time	500	0~9999			
U44	Continue Sewing	0	0-1		0: Off 1: On	
U45	Mid interim D-suction holding	350	0~9999			Reserve
U46	Auto cutter holding time	10	5~500		Adjusting parameters to customer requirements	

U47	R-pedal Suction time	500	50~9999			
U48※	Manual releasing time	280	0~5000			KSC
U49	Manual suction time	260	10~5000			
U50※	F-pedal suction S-N	0	0~60			KSC
U51	R-Pedal suction switch	1	0~7		0 Off ;1ManualOn ;2Semi-AutomaticOn;3Automatic On ;4ManualAndSemi-AutomaticOn ;5Semi-AutomaticandAutomaticOn ;6ManualandAutomaticOn ;7Manual and Semi-Automatic and Automatic On	
U52	R-Pedal trimming switch	1	0~7		0 Off ;1ManualOn ;2Semi-AutomaticOn;3Automatic On ;4ManualAndSemi-AutomaticOn ;5Semi-AutomaticandAutomaticOn ;6ManualandAutomaticOn ;7Manual and Semi-Automatic and Automatic On	
U53	Manual suction switch	7	0~7		0 Off ;1ManualOn ;2Semi-AutomaticOn;3Automatic On ;4ManualAndSemi-AutomaticOn ;5Semi-AutomaticandAutomaticOn ;6ManualandAutomaticOn ;7Manual and Semi-Automatic and Automatic On	
U54	Manual trimming switch	7	0~7		0 Off ;1ManualOn ;2Semi-AutomaticOn;3Automatic On ;4ManualAndSemi-AutomaticOn ;5Semi-AutomaticandAutomaticOn ;6ManualandAutomaticOn ;7Manual and Semi-Automatic and Automatic On	
U55	Manual trimming works	0	0~2		0 Action Without Cloth;1Action With Cloth;2Action Momentarily	
U56※	Manual release works	0	0~2		0 Action Without Cloth;1Action With Cloth;2Action Momentarily	KSC
U57	R-Pedal trimming works	0	0~2		0 Action Without Cloth;1Action With Cloth;2Action Momentarily	
U58※	R-Pedal releasing works	0	0~2		0 Action Without Cloth;1Action With Cloth;2Action Momentarily	KSC
U59※	R-Pedal releasing switch	0	0~7		0 Off ;1ManualOn ;2Semi-AutomaticOn;3Automatic On ;4ManualAndSemi-AutomaticOn ;5Semi-AutomaticandAutomaticOn ;6ManualandAutomaticOn ;7Manual and Semi-Automatic and Automatic On	KSC
U60※	Manual release thread switch	7	0~7		0 Off ;1ManualOn ;2Semi-AutomaticOn;3Automatic On ;4ManualAndSemi-AutomaticOn ;5Semi-AutomaticandAutomaticOn ;6ManualandAutomaticOn ;7Manual and Semi-Automatic and Automatic On	
U61	Side knife drive	0	0~1		0: motor Transmission 1: Electromagnet Transmission	Reserve
U62						Reserve
U63						Reserve
※※	F-thread release on	0	0~100			83BL

	stitches no.					
U64						Reserve
※※	F-thread release off stitches no.	1	1~100			83BL
U65						Reserve
※※	R-thread release on stitches no.	0	0~100			83BL
U66						Reserve
※※	R-thread release off stitches no.	400	5~9000			83BL
U67						Reserve
U68※	F-release on S-N	0	0~600		Adjusting parameters to customer requirements	KSC
※※	F-suction on Stitches no.	1	0~600		Adjusting parameters to customer requirements	83BL
U69※	F-release off Stitches no.	05	0~600		Adjusting parameters to customer requirements	KSC
※※	F-suction off stitches no.	25	0~600		Adjusting parameters to customer requirements	83BL
U70※※	R-Suction on time	300	0~359			83BL
U71※※	R-Suction off time	680	0~9000			83BL
U72※※	R-Pedal suction time	580	0~9000			83BL
U73※※	Speed limit	3500	200~6000			83BL
U74	F-foot lifting	0	0-1		0: Off 1: On	
U75	Needle bar Up or Down	0	0~1		0: Stay Up As Sewing, Stay Down As Stop Sewing 1: Stay Up As Sewing, Stay Down As Stop Sewing	
U76						Reserve
U77	Front sensor response time	30	30~500			
U78	Middle sensor response time	20	20~200			
U79	Rear sensor response time	5	2~200			
U80	Front sensor sensitivity	65	0~99		Unavailable, pls choose the fabric automatic regulating through the hot key	
U81	Middle sensor sensitivity	60	0~99		Unavailable, pls choose the fabric automatic regulating through the hot key	
U82	Rear sensor sensitivity	40	0~99		Unavailable, pls choose the fabric automatic regulating through the hot key	
U83	Front sensor response value	30	5~120		Unavailable, pls choose the fabric automatic regulating through the hot key	
U84	Middle sensor response value	40	5~120		Unavailable, pls choose the fabric automatic regulating through the hot key	
U85	Rear sensor response	40	5~120		Unavailable, pls choose the fabric automatic	

	value				regulating through the hot key	
U86	Safety switch	3	0~3		0: Both off. 1. Presser foot safety switch off.2. sewing bed safety switch off. 3.. Both safety switch on	
U87	Foot SfSw Volt level	0	0~1		0: On 1: Cancel switch	Reserve
U88	Sew table SfSw Volt level	0	0~1		0: On 1: Cancel switch	Reserve
U89	Lift foot protect time	10	5~9999s			
U90	Interface recovery time	120	0~9999		0: Off1~5: Represents 5s Off; 5~9999 (not including5s) : Represent Set Value Off	
U91	Rearlight contrast	18	6~45			
U92	Rearlight brightness	10	0~10			
U93	Head lamp brightness	3	0~5			
U94	Password	0	0~9999			
U95	Restore factory set	0	0~9999			
U96	Languages	0	0~1		0: Chinese 1: English	
U97	Software version 1		0~9999		PA78XX as panel	
※※	Software version 1		0~9999		PA85XX as panel	83BL
U98	Software version 2		0~9999		PC78XX as main board	
※※	Software version 2		0~9999		PC85XX as main board	83BL
U99	Software version 3		0~9999		PB78XX as main board program	
UA0	Volume	20	0~30		Adjusting parameters to customer requirements	

11. Electrical control related requirements and operating precautions

0. Main technical data

Range of voltage: AC220V±15%

Power frequency: 50Hz/60Hz

1、Safety notice

1.1 Range of use

The server-motor is designed for industry sewing machine, when using for other applications, please make sure that the users are safe.

1.2 Working conditions

1.2.1 Any fluctuations in the power voltage should be within the range of ±15% according to the control box marked.

1.2.2 In order to avoid error caused by disturbing control box, please keep away from high frequency electromagnetic emitter.

1.2.3 Humidity:

a. The ambient temperature should be within the range of 5°C to 45°C

during using.

- b. Avoid exposure to direct sun or outdoors during using.
- c. Keep away from the heating (heater) during using.
- d. The relative humidity should be within the range of 30% to 95%.

1.2.4 Keep away from flammable gases or explosive during using.

1.3 Installation

1.3.1 Please install the controller correctly according to the introduction.

1.3.2 Please turn off and disconnect the power cord before installation.

1.3.3 Please keep away from rotating parts when installing the power cord, the distance should be at least 3cm.

1.3.4 In order to prevent noise interference or electric accident, make sure that the sewing machine and the control box are connected to ground. 

1.3.5 Make sure that the fluctuation in the power voltage should be within the range of $\pm 15\%$ according to the control box marked before turning on.

1.4 Maintenance and inspection

1.4.1 Please turn off before maintenance or inspection.

1.4.2 Make sure that the power switch is turned off when turning the machine head, replacing needle or rotary hook.

1.4.3 It is very dangerous because of high voltage inside the control box, if you want to uncover the control box, more than 5 minutes is needed to wait after power off.

1.4.4 Maintenance and inspection of the sewing machine should only be carried out by a qualified technician.

1.4.5 Forbidden to do maintenance and inspection when the motor is running.

1.4.6 All components for repair should be provided or approved before using.

1.5 Dangerous tips



This symbol indicates something you should be careful of when installing, failing to follow the instruction could cause injury when using the machine physical damage to equipment and surroundings.

1.6 Other safety requirements

1.6.1 Please operate the sewing machine at low-speed and check whether the direction of rotation is correct for the first time to power on.

1.6.2 Please don't touch the up wheel, needle and other action parts when

the sewing machine is running .

- 1.6.3 To prevent physical contact, all action parts must be isolated by protective devices, and please don't put anything into the devices.
- 1.6.4 Forbidden to operate at the circumstance of motor hood and other safety devices removed.
- 1.6.5 Don't let motor or control box fall to ground.
- 1.6.6 Don't let liquid ,such as tea, flow into the control box or motor.

2. Installation and adjustment

2.1 Installation of the control box

- 2.1.1 Install the control box and the foot-controllor beneath the table.
- 2.1.2 Please connect the pedal with the control device
- 2.1.3 1).Installation diagram

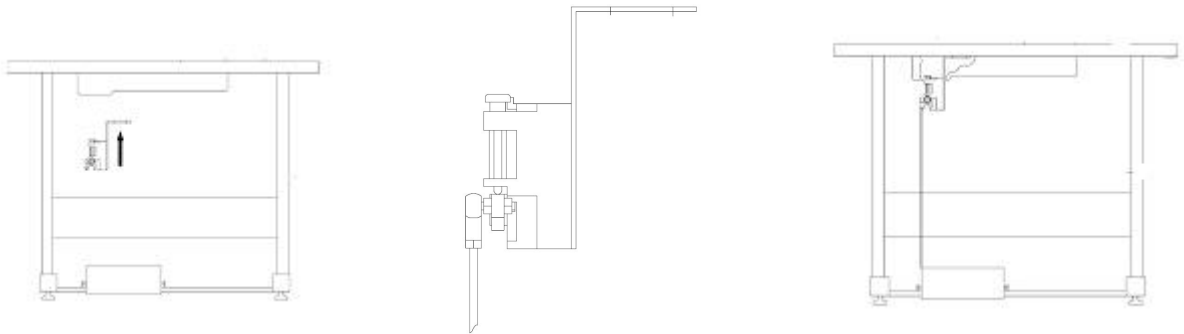

2). Steep slope that connected with the pedal

Adjust the slope of the pedal to adjust the boundary between the low speed area and the acceleration area. Smaller pedal slope, low-speed area is small, tread pedal acceleration feeling smoother。 On the contrary, the low-speed area is large. The feel of acceleration is steeper.

2.2 Adjustment of needle stop position

2.2.1、By professional and technical personnel through the user interface learning interface,

adjust to a reasonable stop needle position;

2.3 Adjustment of the reverse pressure for foot presser

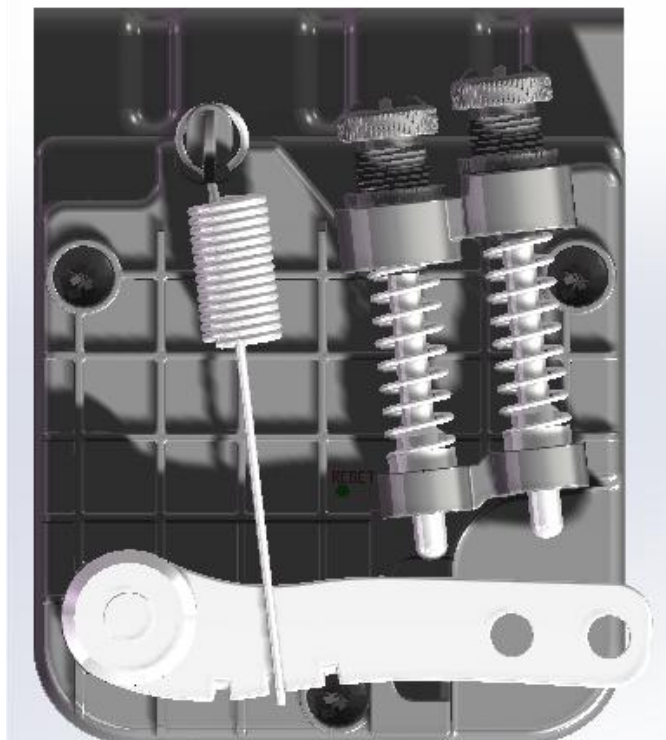

Adjustment requirements	Adjustment result
Adjustment of the reverse pressure for foot presser	Rotate the bolt at down, the reverse pressure will be heavy. Rotate the bolt at up, the reverse pressure will be light.

3. Connection and grounding

3.1 Connection of power supply

The controller is suitable for power supply of AC220V (one phase), the fluctuation of input voltage is within $\pm 15\%$ as the plate marked.



Notice:

The yellow /green power line are connected to ground, the connection to ground must be well done for insurance of safety and devices reliable to work.

3.2 Controller terminal diagram:



序号	Port name	
1	Electric control power access port	
2	34V	Trimming
	34V	Presser foot lift
	34V	Suction
	34V	Puller
	34V	Backlatch stitching(Sunction)
3		Backlatch (Thread release)
		Light
		Middle emission
	12V	Front emission
4	5V	Manual trimming
	5V	Rear emission
4	5V	Front receiver
5	5V	Middle receiver
6	5V	RR receiver
7	5V	GND
	Presser foot Hall	Reserved
8	5V	Sewing table safety Switch
9	5V	Reserved
	GND	NET31-1
10	5V	RXD
	GND	TXD
11	Main program upgrade port	
12	Stepper Motor encoder port	
13	Stepper Motor power port	
14	Motor encoder port	
15	Motor power port	



When the connection plug of each part is inserted into the socket of the control box, be aware of its shape, color and direction, and indeed insert it.

4. Error code analysis

Error Code	Error description	Error reason	Solutions
Er01	Cannot find Stopping needle position	The terminal of the motor signal wire is in poor contact	After power off, check whether the motor signal wire is loose or not, and then power on again. If the problem is still not solved, please contact the service person.
Er02	Speed controller signal error	1: Start without connecting the foot controller 2: The speed controller wire is in poor contact 3. Rear step the pedal to start	After power off, check whether the speed controller is connected or the plug is in poor contact, and then power on again. If the problem is still not solved, please contact the service person.
Er03	Motor phase signal error	bad contact of nine pin plug	After power off, check whether the motor signal wire is loose, and then power on again. If the problem is still not solved, please contact the service person.
Er04	Motor locked rotor protection	1: Sewing machine is overweight or blocked 2: Motor overload 3: Motor 4 wire drive line is not connected or inserted back	Check after power off: 1、Please check if the machine head is stuck 2、Please check if the motor is stuck 3、Check the motor power terminal is off or loose Then power on again, if the problem still cannot be solved, please contact the service person
Er05	Hardware overload protection	1: Sewing machine is overweight or blocked 2: Motor overload 3: The motor phase signal line is not connected properly	Check after power off: 1、Please check if the machine head is stuck 2、Please check if the motor is stuck 3、Check the motor power terminal is off or loose Then power on again, if the problem still cannot be solved, please contact the service person
Er07	Serial communication timeout	1: The connection between the display and the main board is poor 2: The motherboard chip is damaged	1: Check the connection line between the display and the controller 2: Check if the controller is still running, if it can't run, the controller is damaged 3: Check if there is high-frequency machine interference near the machine 4: Replace the display
Er09	Memory damaged	The mainboard memory is damaged or bad	The controller is damaged, please contact service person
Er10	Sensor control circuit fault	Monitor screen and sensor connecting circuit error	1: Monitor Screen damage 2: Screen back sensor circuit Poor contact. Contact the after-sales service
Er12	Encoder Error		Please contact the service person

Er16	Overvoltage	The voltage exceeds the limit	Please check whether the input power voltage is within the rated range (AC 260V), if the above cannot be solved, please contact the service person
Er17	A current checking error		Please contact the service person
Er18	B current checking error		Please contact the service person
Er19	A&B current checking error		Please contact the service person
Er20	Less volt error	The voltage is below the limit	Please check whether the input power voltage is within the rated range (AC 180V), if the above cannot be solved, please contact the service person
Er22	Pedal control error	1.Forward step the pedal to start 2. Controller value incorrect	1. Re-step the speed controller to release 2. Press the P. key+ trimmer to enter maintainence mode, and press the OK key to review(200+_ 15%). If the value is higher, pls change the controller
ER-35	Stepper motor hardware overcurrent protection	1: Check if the signal wire of the stepper motor is loose. 2: Check if the power wire of the stepper motor is loose.	If the above cannot be solved, please contact the service person
ER-37	Stepping motor phase A current detection failure	The motherboard chip is damaged	Please contact the service person
ER-38	Stepper motor phase B current detection failure	The motherboard chip is damaged	Please contact the service person
ER-39	Stepping motor phase AB current detection failure	The motherboard chip is damaged	Please contact the service person
ER-45	Stepper motor encoder failure	Check if the signal wire of the stepper motor is loose.	If the above cannot be solved, please contact the service person

5.This manual is only for reference.

If there is any modification, we apologize for the changing hence caused.

WJLXJY 817c4c38

535795466

Dj74



富山IoT



微信公众号



抖音官方号

上海富山精密机械科技有限公司

HIKARI (SHANGHAI) PRECISE MACHINERY SCIENCE AND TECHNOLOGY CO., LTD

邮箱/E-mail: hikari@chinahikari.com

网址/Web: www.chinahikari.com

传真/Fax: (00)86-21-67311311

电话/Tel: (00)86-21-67311111 (转外贸部/ext .Foreign Trade Dept)

上海市金山区朱泾镇工业园区中达路800号

NO.800, ZHONGDA ROAD, ZHUJING INDUSTRIAL ZONE,

JINSHAN DISTRICT, SHANGHAI CHINA



QUANTITY ATTESTATION
ISO9001质量体系认证